

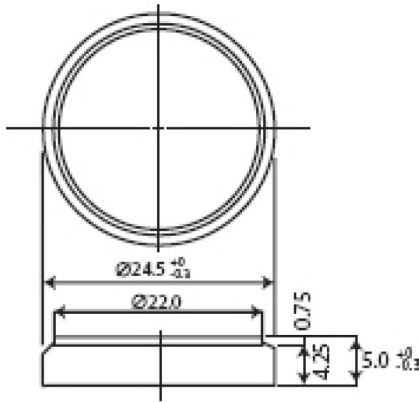

CR2450

Lithium Manganese Dioxide
(Li-MnO₂) Coin Batteries

Dimensions(mm)



Nominal capacity (15KΩ, 2.0V off)	600mAh
Nominal voltage	3.0V
Max. constant current	6mA
Max. pulse current	25mA
Operating temperature	-20~+70°C
Weight	7.0g

WARNING

- Do not short-circuit between "+" and "-" terminals.
- Do not charge, damage the battery or throw it into fire.
- Do not solder directly on the battery. Please use wire or nickel sheet by spot welding.
- Take out the battery when discharged to cut-off voltage, and dispose of according to the national and local laws.

1. TEMPERATURE CHARACTERISTICS

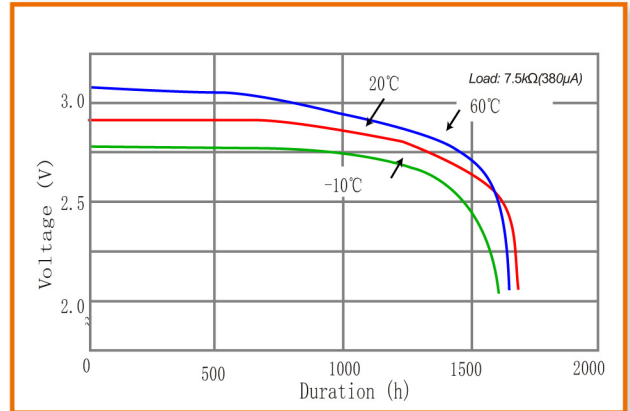

2. OPERATING VOLTAGE VS. LOAD RESISTANCE

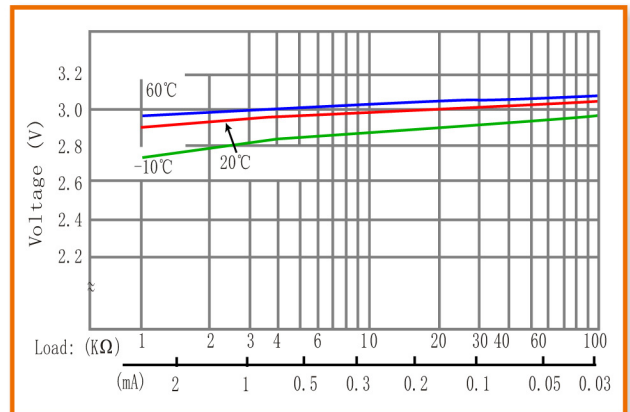

3. CAPACITY VS. LOAD RESISTANCE

