

TOS-18104BMB-B

Single Digit Display LED

Part Number	Chip		Face Color	Segment Color
	Material	Source Color		
TOS-18104BMB-B	InGaN	Hi-blue	Black	White

Features

- (1.80") 45.0mm digit height
- Common anode
- I.C. compatible
- Low power requirement
- RoHS compliant

Applications

- Audio equipment
- Instrument panels
- Digital read out display

Package Dimensions & Internal Circuit Diagram

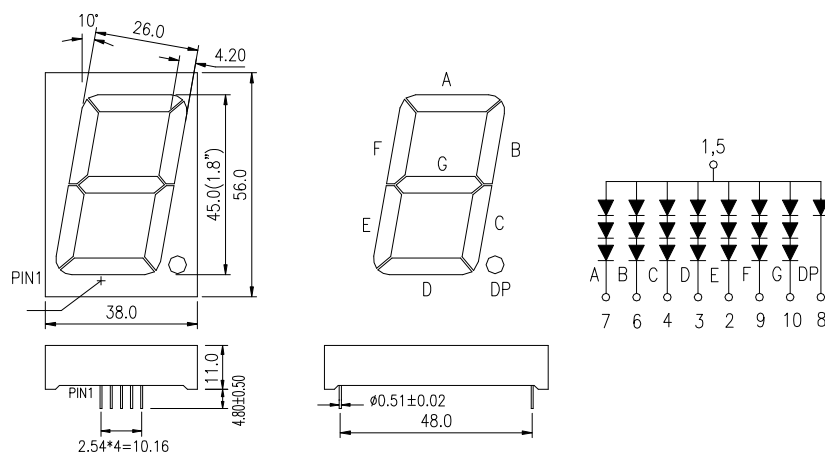

Notes:

1. All dimensions are in millimeters, tolerance: ± 0.25 ; Angle: $\pm 0.1^\circ$ unless otherwise noted.
2. Specifications are subject to change without notice.

Absolute Maximum Rating @ Ta=25°C

Parameter	Maximum Rating	Unit
Peak Forward Current (1/10 Duty Cycle, 0.1ms Pulse Width)	80	mA
Power Dissipation Per Dice	105	mW
Continuous Forward Current Per Dice	20	mA
Recommend Operating Current Per Dice	12	mA
Reverse Voltage Per Dice	5	V
Operating Temperature Range	-25°C to +85°C	
Storage Temperature Range	-30°C to +85°C	
Lead-Free Solder Temperature(1/16 Inch Below Seating Plane)	260°C for 3 Sec	

Electrical / Optical Characteristic @ Ta=25°C

Parameter	Symbol	Min.	Typ.	Max.	Unit	Test Condition	Grade
Luminous Intensity	I _v		32907		ucd	I _F =10mA	
Dominant Wavelength	λ _d		465		nm	I _F =20mA	
Spectral Line Half-Width	Δλ		26		nm	I _F =20mA	
Forward Voltage Per Dice	V _F		3.5	4.0	V	I _F =20mA	
Reverse Current Per Dice	I _R			100	μA	V _R =5V	
Luminous Intensity Matching Rate	I _v -m			2.0:1		I _F =20mA	