

Metal Oxide Varistor : TVR-M Series

High Temperature Varistor for Surge Protection

■ Features

1. RoHS and Halogen-free compliant
2. Body size: $\Phi 5 \sim \Phi 20\text{mm}$
3. Wide continuous voltage range: 130Vac ~ 465Vac
4. Operating temperature range: $-40^{\circ}\text{C} \sim +125^{\circ}\text{C}$
Storage temperature range: $-40^{\circ}\text{C} \sim +150^{\circ}\text{C}$
5. UL 1449 3rd SPD Type 5
6. Agency recognition: UL /cUL/VDE/CQC

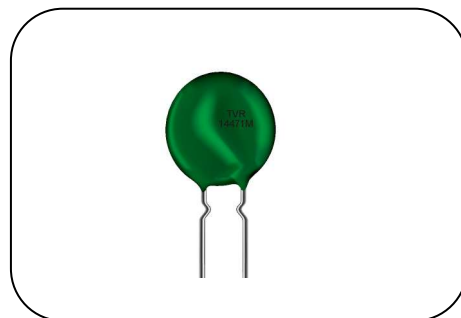

■ Recommended Applications

1. Power supply
2. Home appliance
3. Industrial equipment
4. LED driver
5. Photovoltaic industry

■ Part Number Code

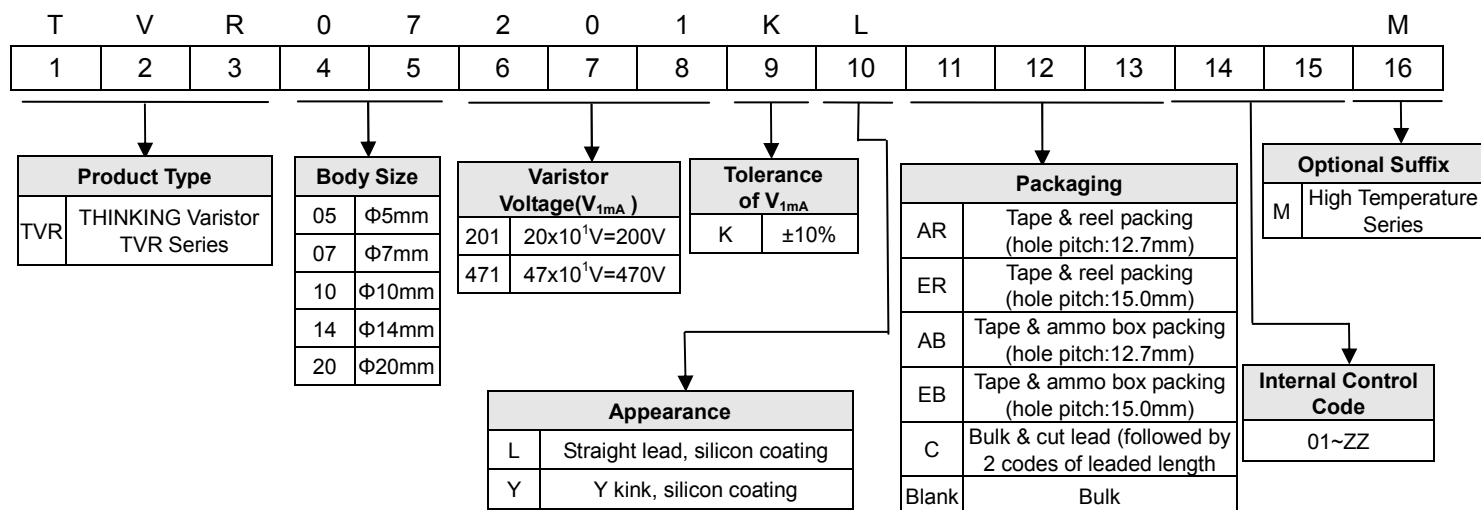

Note: Optional suffix will be the 11th digit if packaging and internal control codes are not coded.

Metal Oxide Varistor : TVR-M Series

High Temperature Varistor for Surge Protection

Structures and Dimensions

- Straight Lead

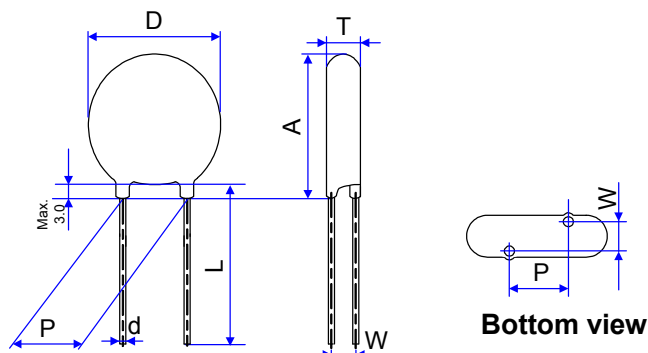

(Unit: mm)

Series	D	Lmin.	d	P	Amax.	Tmax.	W
TVR05-M	5.0~7.5	26.5	0.6±0.02	5±1	9.0	Please refer to the Electrical Characteristics Table	
TVR07-M	6.4~9.6	26.5	0.6±0.02	5±1	11.0 (for TVR07201~621) 11.5 (for TVR07681~751)		
TVR10-M	9.6~14.4	26.5	0.8±0.02	7.5±1	15.0 (for TVR10201-751)		
TVR14-M	12.0~18.0	26.5	0.8±0.02	7.5±1	18.5 (for TVR14201-511) 19.0 (for TVR14561-751)		
TVR20-M	16.8~25.2	22.5	1.0±0.02	10±1	25.5 (for TVR20201-511) 26.0 (for TVR20561-751)		

- Y kink lead

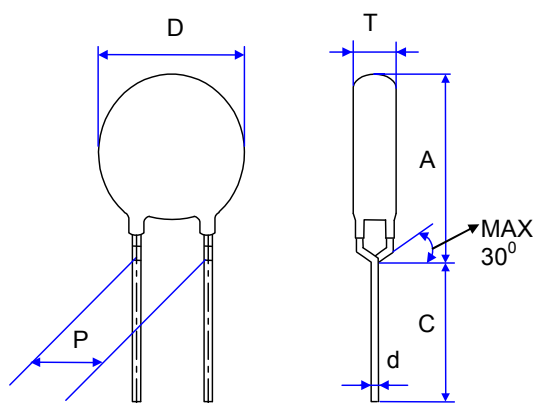

(Unit: mm)

Series	D	Cmin.	d	P	Amax.	Tmax.
TVR05-M	5.0~7.5	20	0.6±0.02	5±1	9.5	Please refer to the Electrical Characteristics Table
TVR07-M	6.4~9.6		0.6±0.02	5±1	11.5	
TVR10-M	9.6~14.4		0.8±0.02	7.5±1	16.0	
TVR14-M	12.0~18.0		0.8±0.02	7.5±1	19.0	
TVR20-M	16.8~25.2		1.0±0.02	10±1	26.5	

If short lead (cut lead) is requested, 3.5±0.5mm is the suggested dimension of C.

Metal Oxide Varistor : TVR-M Series

High Temperature Varistor for Surge Protection

■ Electrical Characteristics

05mm Series

Part No.	Varistor Voltage (@ 1mA DC)	Max. Continuous Voltage		Max. Clamping Voltage (8/20 μ s)		Max. Surge Current (8/20 μ s)	Nominal Discharge Current ^{*1} (8/20 μ s)	Rated Power	Max. Energy (10/1000 μ s)	Dimension		
	V _{1mA}	V _{AC(rms)}	V _{DC}	V _P	I _P	I _{max}	I _n	P	W _{max}	T _{min}	T _{max}	W ± 1.0
	(V)	(V)	(V)	(V)	(A)	(A)	(A)	(W)	(J)	(mm)		
TVR05201-M	200 (180~220)	130	170	355	5	400	100	0.1	3.5	3.20	4.80	1.5
TVR05221-M	220 (198~242)	140	180	380	5	400	100	0.1	8.5	3.36	5.04	1.5
TVR05241-M	240 (216~264)	150	200	415	5	400	100	0.1	9.0	3.44	5.16	1.6
TVR05271-M	270 (243~297)	175	225	475	5	400	100	0.1	10.5	3.52	5.28	1.7
TVR05301-M	300 (270~330)	195	250	525	5	400	100	0.1	11	3.60	5.40	1.9
TVR05331-M	330 (297~363)	215	275	585	5	400	100	0.1	13	3.76	5.64	2.0
TVR05361-M	360 (324~396)	230	300	620	5	400	100	0.1	16	3.92	5.88	2.1
TVR05391-M	390 (351~429)	250	320	675	5	400	100	0.1	17	4.00	6.00	2.3
TVR05431-M	430 (387~473)	275	350	745	5	400	100	0.1	20	4.16	6.24	2.3
TVR05471-M	470 (423~517)	300	385	810	5	400	100	0.1	21	4.24	6.36	2.4
TVR05511-M	510 (459~561)	320	410	878	5	400	100	0.1	16	4.40	6.60	2.6
TVR05561-M	560 (504~616)	350	450	962	5	400	100	0.1	18	4.56	6.84	2.8
TVR05621-M	620 (558~682)	395	510	1050	5	400	100	0.1	18	4.88	7.32	3.0

Note:

*1: Nominal discharge current is the specification defined in UL 1449 and uses 8/20 μ s current waveform to test the varistor.

Metal Oxide Varistor : TVR-M Series

High Temperature Varistor for Surge Protection

07mm Series

Part No.	Varistor Voltage (@ 1mA DC)	Max. Continuous Voltage		Max. Clamping Voltage (8/20 μ s)		Max. Surge Current (8/20 μ s)	Nominal Discharge Current ^{*1} (8/20 μ s)	Rated Power	Max. Energy (10/1000 μ s)	Dimension		
	V _{1mA}	V _{AC(rms)}	V _{DC}	V _P	I _P	I _{max}	I _n	P	W _{max}	T _{min}	T _{max}	W ± 1.0
	(V)	(V)	(V)	(V)	(A)	(A)	(A)	(W)	(J)	(mm)		
TVR07201-M	200 (180~220)	130	170	340	10	1750	500	0.25	17.5	3.20	4.80	1.5
TVR07221-M	220 (198~242)	140	180	360	10	1750	500	0.25	19	3.28	4.92	1.5
TVR07241-M	240 (216~264)	150	200	395	10	1750	500	0.25	21	3.44	5.16	1.6
TVR07271-M	270 (243~297)	175	225	455	10	1750	500	0.25	24	3.52	5.28	1.7
TVR07301-M	300 (270~330)	195	250	500	10	1750	500	0.25	26	3.60	5.40	1.9
TVR07331-M	330 (297~363)	215	275	550	10	1750	500	0.25	28	3.76	5.64	2.0
TVR07361-M	360 (324~396)	230	300	595	10	1750	500	0.25	32	3.92	5.88	2.1
TVR07391-M	390 (351~429)	250	320	650	10	1750	500	0.25	35	4.00	6.00	2.3
TVR07431-M	430 (387~473)	275	350	710	10	1750	500	0.25	40	4.16	6.24	2.3
TVR07471-M	470 (423~517)	300	385	775	10	1750	500	0.25	42	4.24	6.36	2.4
TVR07511-M	510 (459~561)	320	410	845	10	1750	500	0.25	45	4.40	6.60	2.6
TVR07561-M	560 (504~616)	350	450	930	10	1750	500	0.25	45.5	4.56	6.84	2.8
TVR07621-M	620 (558~682)	395	510	1020	10	1750	500	0.25	50	4.88	7.32	3.0
TVR07681-M	680 (612~748)	420	560	1120	10	1750	500	0.25	50.5	5.04	7.56	3.2
TVR07751-M	750 (675~825)	465	615	1235	10	1750	500	0.25	51	5.20	7.80	3.5

Note:

*1: Nominal discharge current is the specification defined in UL 1449 and uses 8/20 μ s current waveform to test the varistor.

Metal Oxide Varistor : TVR-M Series

High Temperature Varistor for Surge Protection

10mm Series

Part No.	Varistor Voltage (@ 1mA DC)	Max. Continuous Voltage		Max. Clamping Voltage (8/20 μ s)		Max. Surge Current (8/20 μ s)	Nominal Discharge Current ¹ (8/20 μ s)	Rated Power	Max. Energy (10/1000 μ s)	Dimension		
	V _{1mA}	V _{AC(rms)}	V _{DC}	V _P	I _P	I _{max}	I _n	P	W _{max}	T _{min}	T _{max}	W ± 1.0
	(V)	(V)	(V)	(V)	(A)	(A)	(A)	(W)	(J)	(mm)		
TVR10201-M	200 (180~220)	130	170	340	25	3500	1000	0.4	35	3.60	5.40	1.7
TVR10221-M	220 (198~242)	140	180	360	25	3500	1000	0.4	39	3.68	5.52	1.7
TVR10241-M	240 (216~264)	150	200	395	25	3500	1000	0.4	42	3.84	5.76	1.8
TVR10271-M	270 (243~297)	175	225	455	25	3500	1000	0.4	49	3.92	5.88	1.9
TVR10301-M	300 (270~330)	195	250	500	25	3500	1000	0.4	53	4.00	6.00	2.1
TVR10331-M	330 (297~363)	215	275	550	25	3500	1000	0.4	58	4.16	6.24	2.2
TVR10361-M	360 (324~396)	230	300	595	25	3500	1000	0.4	65	4.24	6.36	2.3
TVR10391-M	390 (351~429)	250	320	650	25	3500	1000	0.4	70	4.32	6.48	2.5
TVR10431-M	430 (387~473)	275	350	710	25	3500	1000	0.4	80	4.40	6.60	2.5
TVR10471-M	470 (423~517)	300	385	775	25	3500	1000	0.4	85	4.64	6.96	2.6
TVR10511-M	510 (459~561)	320	410	845	25	3500	1000	0.4	92	4.88	7.32	2.8
TVR10561-M	560 (504~616)	350	450	930	25	3500	1000	0.4	92	4.96	7.44	3.0
TVR10621-M	620 (558~682)	395	510	1020	25	3500	1000	0.4	92	5.12	7.68	3.2
TVR10681-M	680 (612~748)	420	560	1120	25	3500	1000	0.4	92	5.28	7.92	3.4
TVR10751-M	750 (675~825)	465	615	1235	25	3500	1000	0.4	100	5.44	8.16	3.7

Note:

*1: Nominal discharge current is the specification defined in UL 1449 and uses 8/20 μ s current waveform to test the varistor.

Metal Oxide Varistor : TVR-M Series

High Temperature Varistor for Surge Protection

14mm Series

Part No.	Varistor Voltage (@ 1mA DC)	Max. Continuous Voltage		Max. Clamping Voltage (8/20 μ s)		Max. Surge Current (8/20 μ s)	Nominal Discharge Current ¹ (8/20 μ s)	Rated Power	Max. Energy (10/1000 μ s)	Dimension		
	V _{1mA}	V _{AC(rms)}	V _{DC}	V _P	I _P	I _{max}	I _n	P	W _{max}	T _{min}	T _{max}	W ± 1.0
	(V)	(V)	(V)	(V)	(A)	(A)	(A)	(W)	(J)	(mm)		
TVR14201-M	200 (180~220)	130	170	340	50	6000	3000	0.6	70	3.60	5.40	1.7
TVR14221-M	220 (198~242)	140	180	360	50	6000	3000	0.6	78	3.68	5.52	1.7
TVR14241-M	240 (216~264)	150	200	395	50	6000	3000	0.6	84	3.84	5.76	1.8
TVR14271-M	270 (243~297)	175	225	455	50	6000	3000	0.6	99	3.92	5.88	1.9
TVR14301-M	300 (270~330)	195	250	500	50	6000	3000	0.6	105	4.00	6.00	2.1
TVR14331-M	330 (297~363)	215	275	550	50	6000	3000	0.6	115	4.16	6.24	2.2
TVR14361-M	360 (324~396)	230	300	595	50	6000	3000	0.6	130	4.24	6.36	2.3
TVR14391-M	390 (351~429)	250	320	650	50	6000	3000	0.6	140	4.32	6.48	2.5
TVR14431-M	430 (387~473)	275	350	710	50	6000	3000	0.6	155	4.40	6.60	2.5
TVR14471-M	470 (423~517)	300	385	775	50	6000	3000	0.6	175	4.64	6.96	2.6
TVR14511-M	510 (459~561)	320	410	845	50	6000	3000	0.6	190	4.88	7.32	2.8
TVR14561-M	560 (504~616)	350	450	930	50	6000	3000	0.6	190	4.96	7.44	3.0
TVR14621-M	620 (558~682)	395	510	1020	50	6000	3000	0.6	190	5.12	7.68	3.2
TVR14681-M	680 (612~748)	420	560	1120	50	6000	3000	0.6	190	5.28	7.92	3.4
TVR14751-M	750 (675~825)	465	615	1235	50	6000	3000	0.6	210	5.44	8.16	3.7

Note:

*1: Nominal discharge current is the specification defined in UL 1449 and uses 8/20 μ s current waveform to test the varistor.

Metal Oxide Varistor : TVR-M Series

High Temperature Varistor for Surge Protection

20mm Series

Part No.	Varistor Voltage (@ 1mA DC)	Max. Continuous Voltage		Max. Clamping Voltage (8/20 μ s)		Max. Surge Current (8/20 μ s)	Nominal Discharge Current ¹ (8/20 μ s)	Rated Power	Max. Energy (10/1000 μ s)	Dimension		
	V _{1mA}	V _{AC(rms)}	V _{DC}	V _P	I _P	I _{max}	I _n	P	W _{max}	T _{min}	T _{max}	W \pm 1.0
	(V)	(V)	(V)	(V)	(A)	(A)	(A)	(W)	(J)	(mm)		
TVR20201-M	200 (180~220)	130	170	340	100	10000	3000	1.0	140	3.84	5.76	1.9
TVR20221-M	220 (198~242)	140	180	360	100	10000	3000	1.0	155	3.92	5.88	1.9
TVR20241-M	240 (216~264)	150	200	395	100	10000	3000	1.0	168	4.08	6.12	2.0
TVR20271-M	270 (243~297)	175	225	455	100	10000	3000	1.0	190	4.16	6.24	2.1
TVR20301-M	300 (270~330)	195	250	500	100	10000	3000	1.0	210	4.24	6.36	2.3
TVR20331-M	330 (297~363)	215	275	550	100	10000	3000	1.0	228	4.32	6.48	2.4
TVR20361-M	360 (324~396)	230	300	595	100	10000	3000	1.0	255	4.40	6.60	2.5
TVR20391-M	390 (351~429)	250	320	650	100	10000	3000	1.0	275	4.48	6.72	2.7
TVR20431-M	430 (387~473)	275	350	710	100	10000	3000	1.0	303	4.56	6.84	2.7
TVR20471-M	470 (423~517)	300	385	775	100	10000	3000	1.0	350	4.88	7.32	2.8
TVR20511-M	510 (459~561)	320	410	845	100	10000	3000	1.0	382	5.12	7.68	3.0
TVR20561-M	560 (504~616)	350	450	930	100	10000	3000	1.0	382	5.20	7.80	3.2
TVR20621-M	620 (558~682)	395	510	1020	100	10000	3000	1.0	382	5.36	8.04	3.4
TVR20681-M	680 (612~748)	420	560	1120	100	10000	3000	1.0	382	5.52	8.28	3.6
TVR20751-M	750 (675~825)	465	615	1235	100	10000	3000	1.0	420	5.68	8.52	3.9



Note:

*1: Nominal discharge current is the specification defined in UL 1449 3rd and uses 8/20 μ s current waveform to test the varistor.

Metal Oxide Varistor : TVR-M Series



High Temperature Varistor for Surge Protection

■ Safety Approvals

Certified Model No.	Agency		
			
	UL1449 & cUL	EN/IEC 61051	GB/T10193-1997 GB/T10194-1997
	E314979	40036061	CQC13001090356 CQC13001090357
TVR05201-M	√	√	√
TVR05221-M	√	√	√
TVR05241-M	√	√	√
TVR05271-M	√	√	√
TVR05301-M	√	√	√
TVR05331-M	√	√	√
TVR05361-M	√	√	√
TVR05391-M	√	√	√
TVR05431-M	√	√	√
TVR05471-M	√	√	√
TVR05511-M	√	√	√
TVR05561-M	√	√	√
TVR05621-M	√	√	√
TVR07201-M	√	√	√
TVR07221-M	√	√	√
TVR07241-M	√	√	√
TVR07271-M	√	√	√
TVR07301-M	√	√	√
TVR07331-M	√	√	√
TVR07361-M	√	√	√
TVR07391-M	√	√	√
TVR07431-M	√	√	√
TVR07471-M	√	√	√
TVR07511-M	√	√	√
TVR07561-M	√	√	√
TVR07621-M	√	√	√
TVR07681-M	√	√	√
TVR07751-M	√	√	√



Metal Oxide Varistor : TVR-M Series

High Temperature Varistor for Surge Protection

Certified Model No.	Agency				
					
	UL1449 & cUL	EN/IEC 61051	IEC 60950-1 2013 Annex Q	GB/T10193-1997 GB/T10194-1997	GB8898-2011 GB4943.1-2011
	E314979	40036061		CQC13001090356 CQC13001090357	CQC13001090356 CQC13001090357
TVR10201-M	√	√	√	√	
TVR10221-M	√	√	√	√	
TVR10241-M	√	√	√	√	
TVR10271-M	√	√	√	√	
TVR10301-M	√	√	√	√	
TVR10331-M	√	√	√	√	
TVR10361-M	√	√	√	√	
TVR10391-M	√	√	√	√	
TVR10431-M	√	√	√	√	√
TVR10471-M	√	√	√	√	√
TVR10511-M	√	√	√	√	√
TVR10561-M	√	√	√	√	√
TVR10621-M	√	√	√	√	√
TVR10681-M	√	√	√	√	√
TVR10751-M	√	√	√	√	√
TVR14201-M	√	√	√	√	
TVR14221-M	√	√	√	√	
TVR14241-M	√	√	√	√	
TVR14271-M	√	√	√	√	
TVR14301-M	√	√	√	√	
TVR14331-M	√	√	√	√	
TVR14361-M	√	√	√	√	
TVR14391-M	√	√	√	√	
TVR14431-M	√	√	√	√	√
TVR14471-M	√	√	√	√	√
TVR14511-M	√	√	√	√	√
TVR14561-M	√	√	√	√	√
TVR14621-M	√	√	√	√	√
TVR14681-M	√	√	√	√	√
TVR14751-M	√	√	√	√	√

Metal Oxide Varistor : TVR-M Series

High Temperature Varistor for Surge Protection

Certified Model No.	Agency				
					
	UL1449 & cUL	EN/IEC 61051	IEC 60950-1 2013 Annex Q	GB/T10193-1997 GB/T10194-1997	GB8898-2011 GB4943.1-2011
	E314979	40036061		CQC13001090356 CQC13001090357	CQC13001090356 CQC13001090357
TVR20201-M	√	√	√	√	
TVR20221-M	√	√	√	√	
TVR20241-M	√	√	√	√	
TVR20271-M	√	√	√	√	
TVR20301-M	√	√	√	√	
TVR20331-M	√	√	√	√	
TVR20361-M	√	√	√	√	
TVR20391-M	√	√	√	√	
TVR20431-M	√	√	√	√	√
TVR20471-M	√	√	√	√	√
TVR20511-M	√	√	√	√	√
TVR20561-M	√	√	√	√	√
TVR20621-M	√	√	√	√	√
TVR20681-M	√	√	√	√	√
TVR20751-M	√	√	√	√	√

Metal Oxide Varistor : TVR-M Series

High Temperature Varistor for Surge Protection

Power Derating Curve

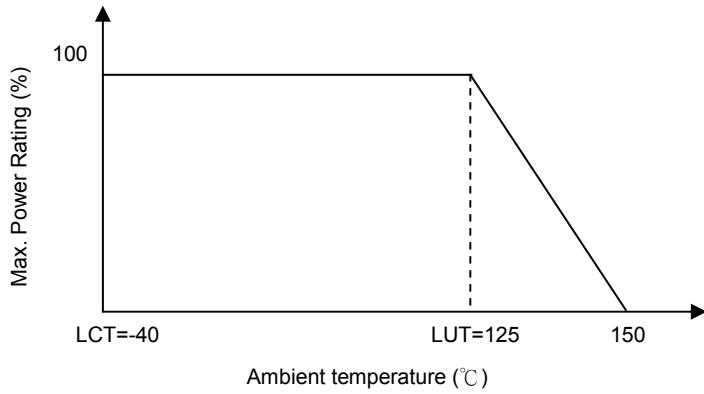

Surge Current Standard Waveform

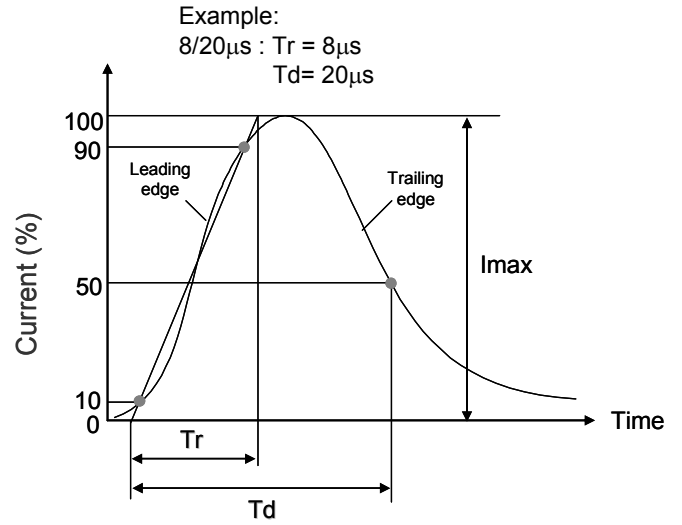

Max. Surge Current Derating Curves

TVR05201-M ~ TVR05751-M

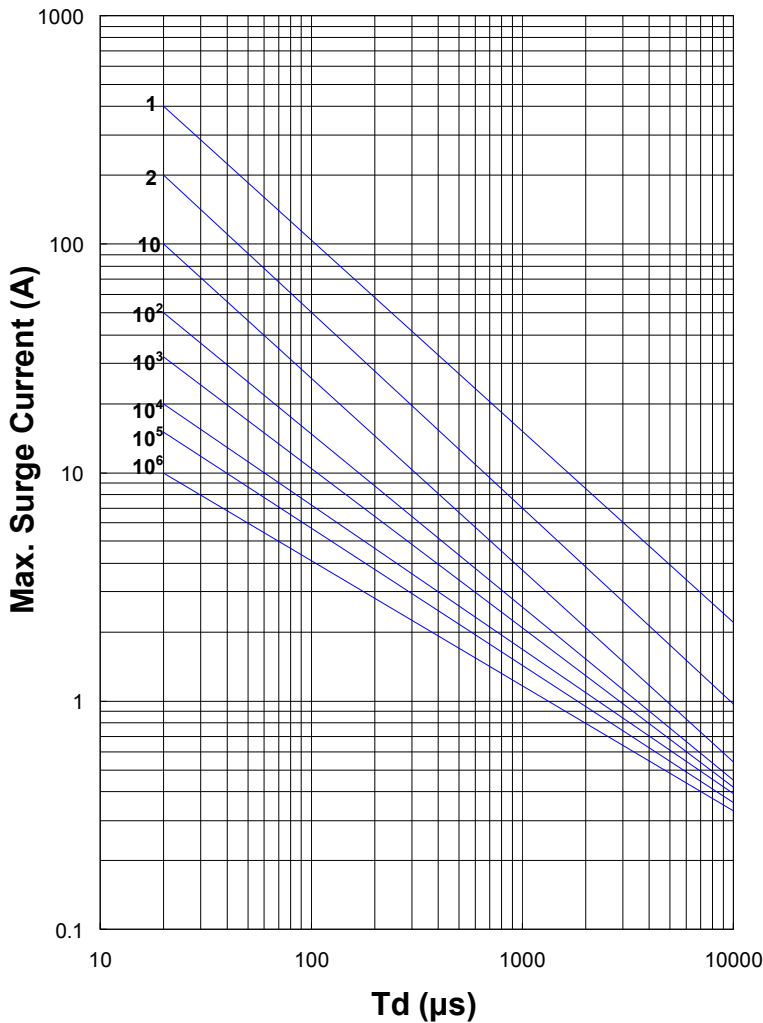

TVR07201-M ~ TVR07751-M

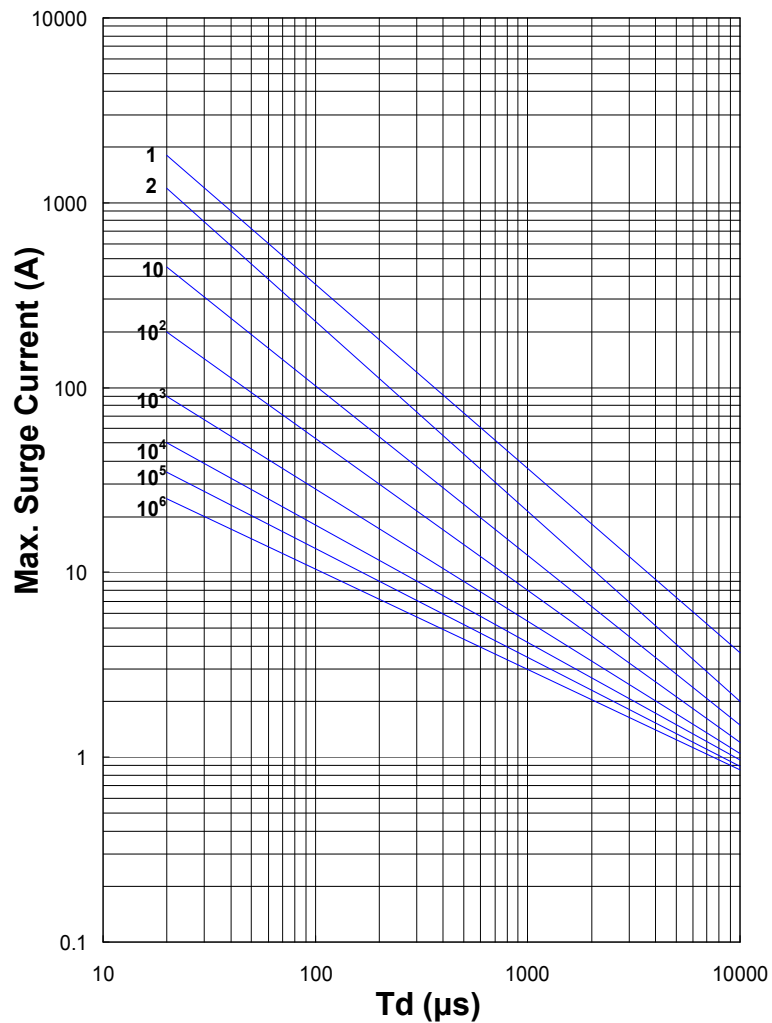

Metal Oxide Varistor : TVR-M Series

High Temperature Varistor for Surge Protection

■ Max. Surge Current Derating Curves

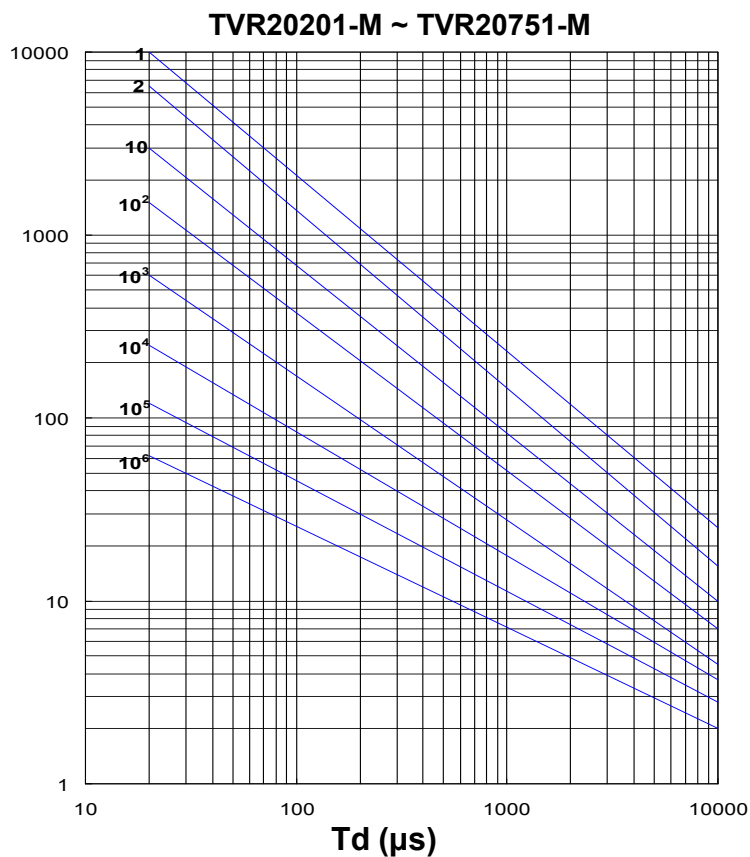
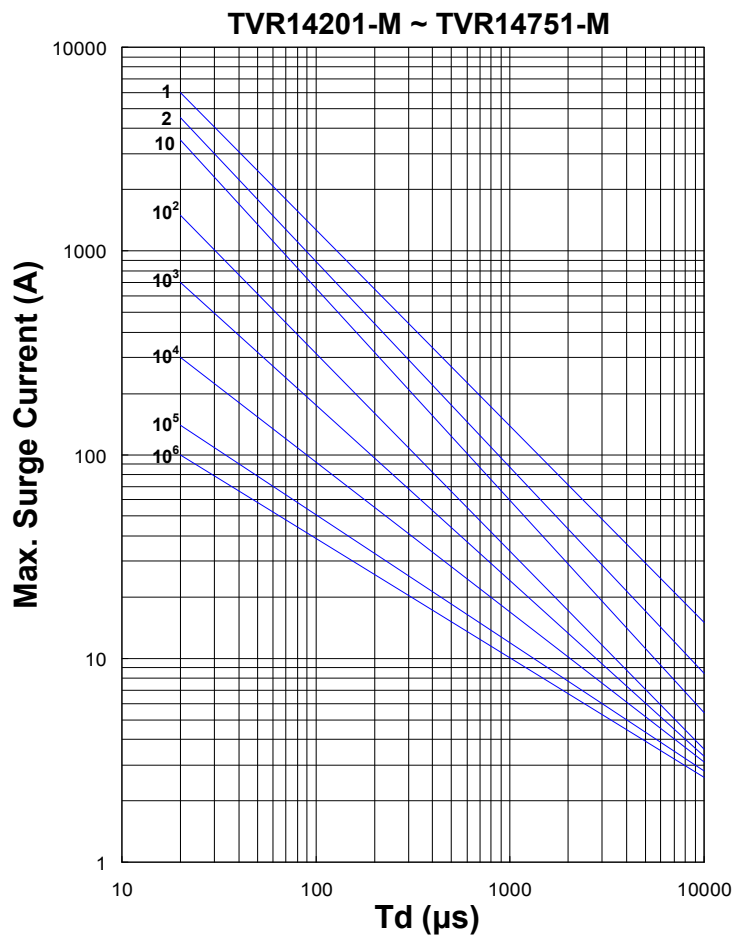
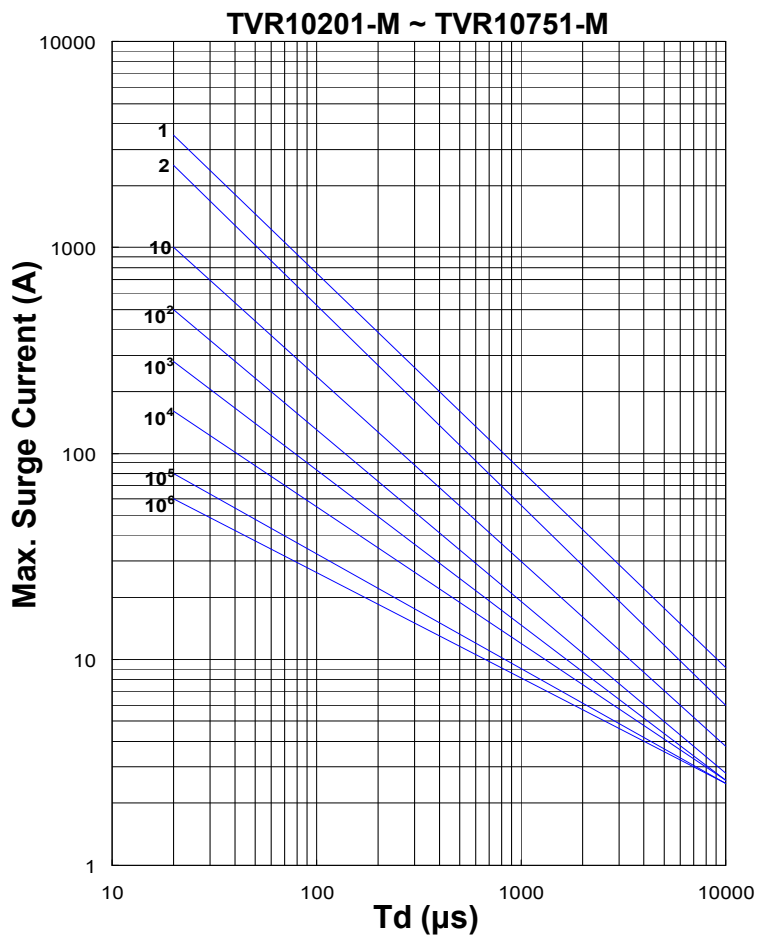

Metal Oxide Varistor : TVR-M Series

High Temperature Varistor for Surge Protection

■ Max. Leakage Current and Max. Clamping Voltage Curves

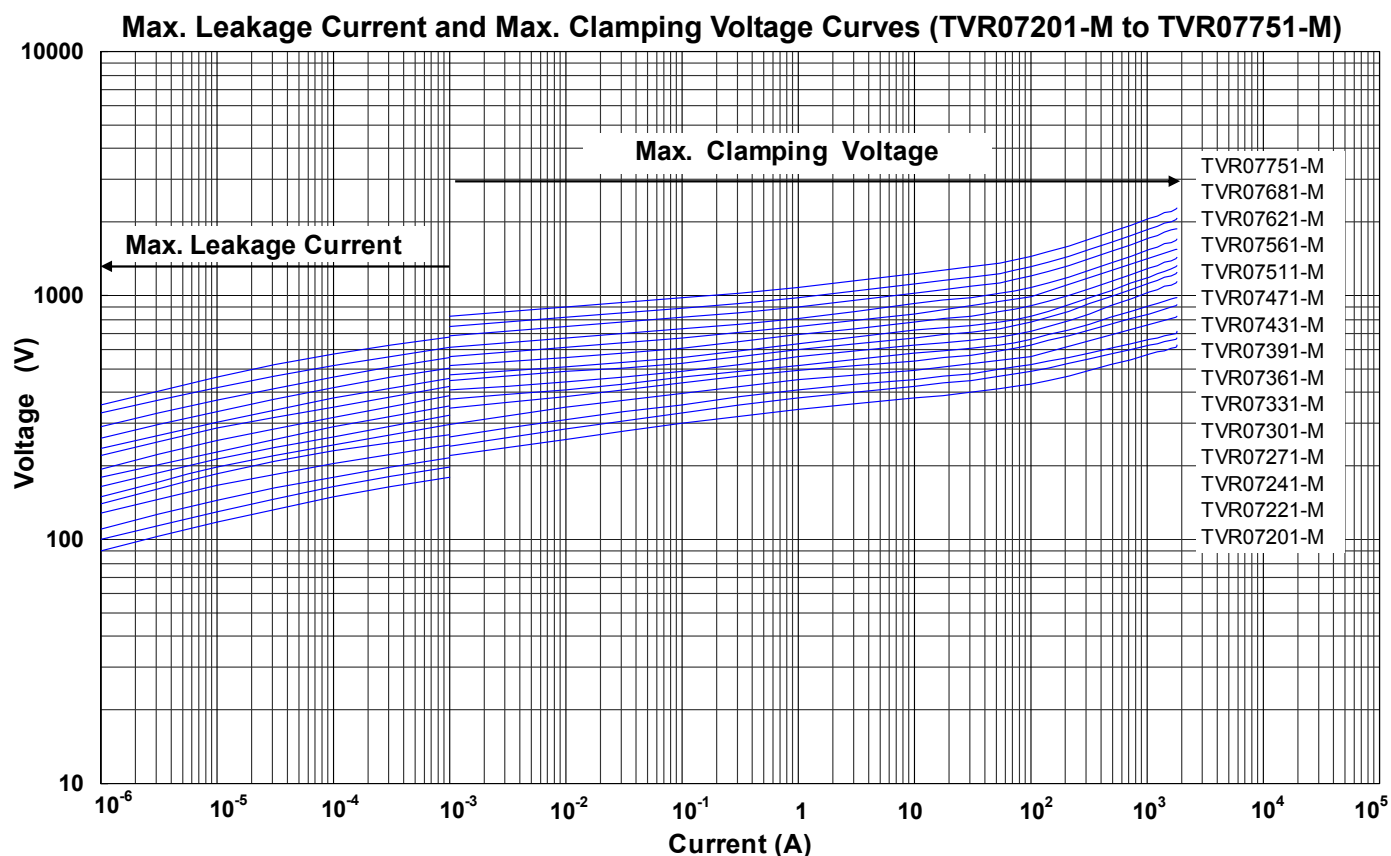
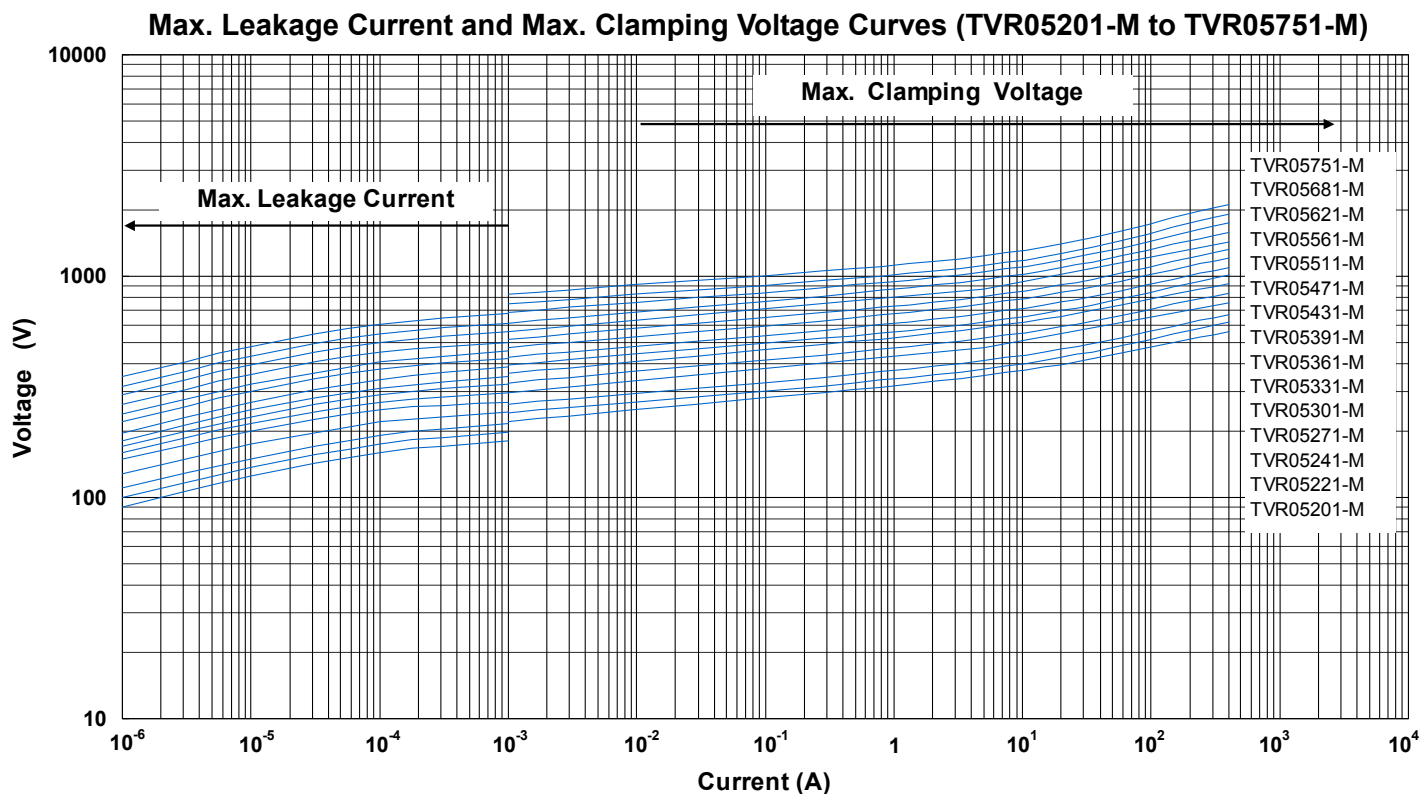

Metal Oxide Varistor : TVR-M Series

High Temperature Varistor for Surge Protection

Max. Leakage Current and Max. Clamping Voltage Curves

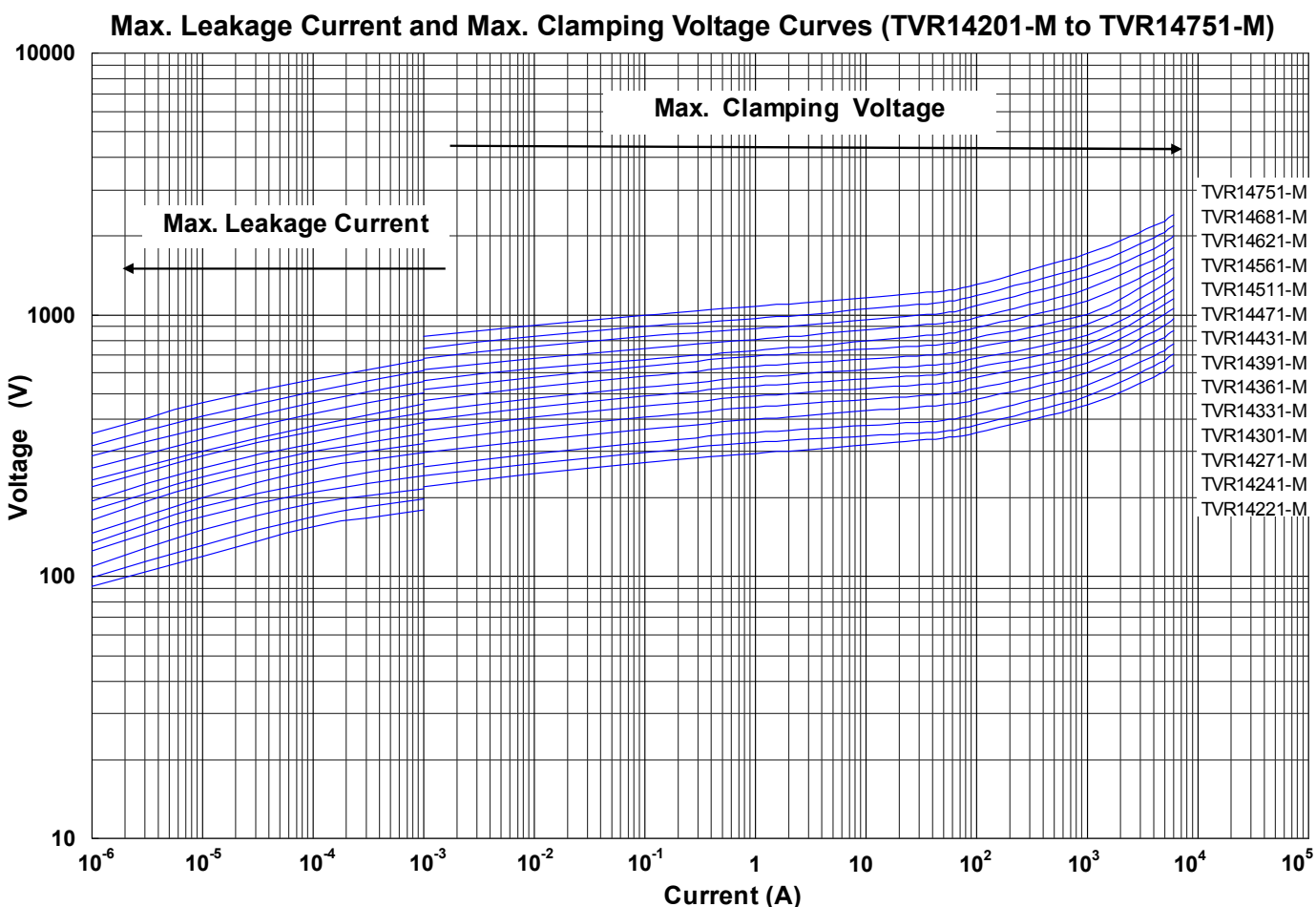
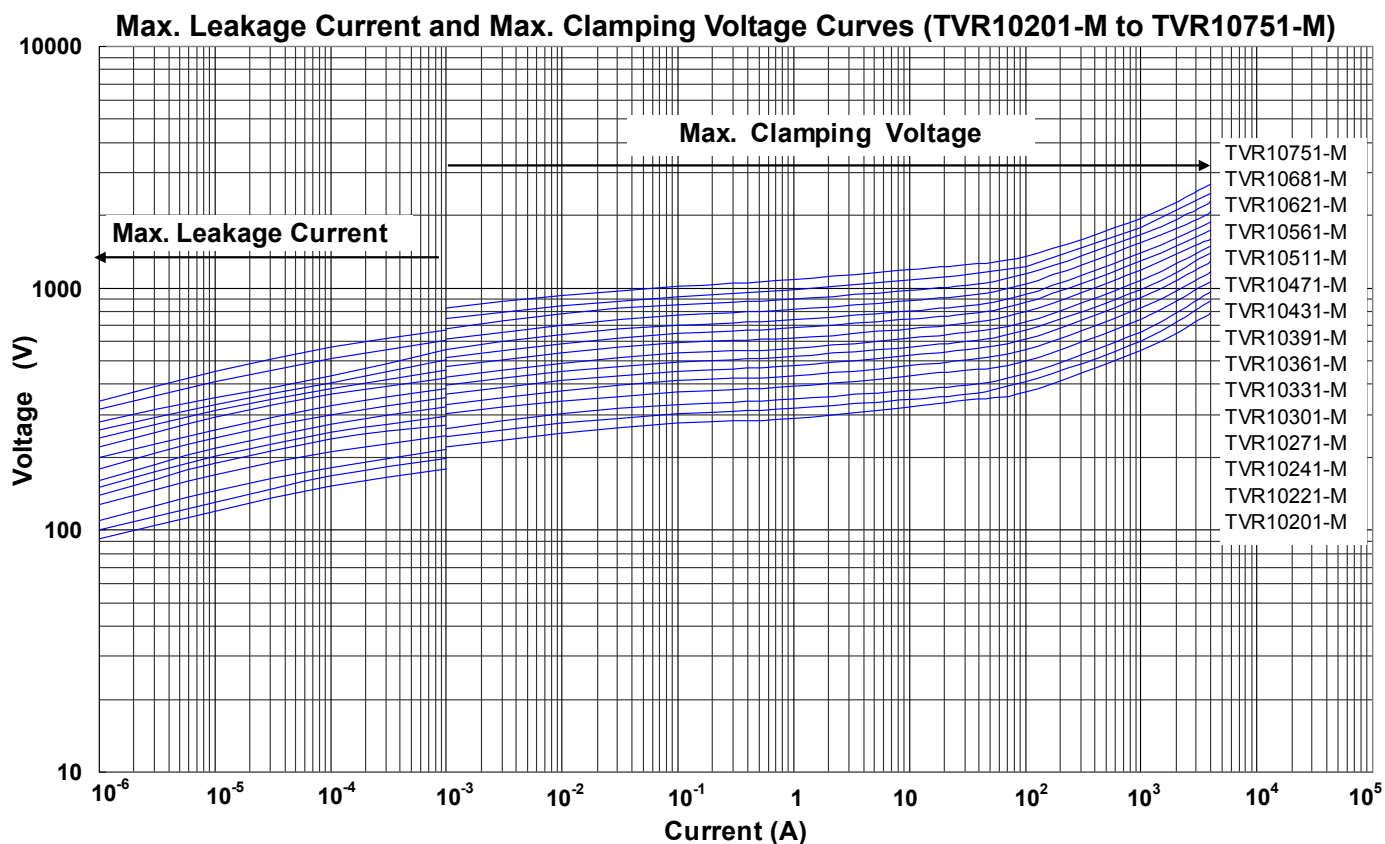

Metal Oxide Varistor : TVR-M Series

High Temperature Varistor for Surge Protection

■ Max. Leakage Current and Max. Clamping Voltage Curves

Max. Leakage Current and Max. Clamping Voltage Curves (TVR20201-M to TVR20751-M)

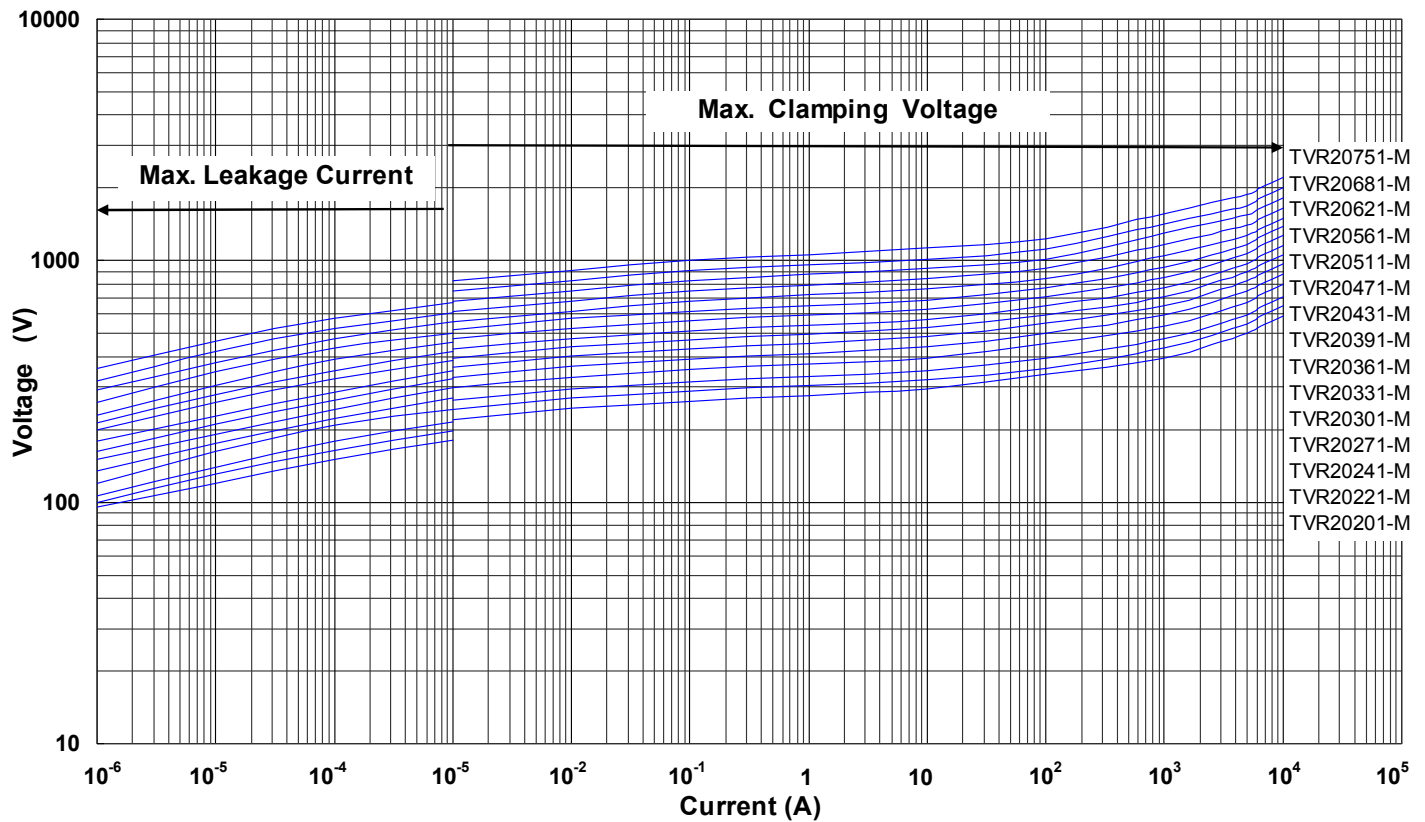

Metal Oxide Varistor : TVR-M Series

High Temperature Varistor for Surge Protection

■ Soldering Recommendation

● Wave Soldering Profile

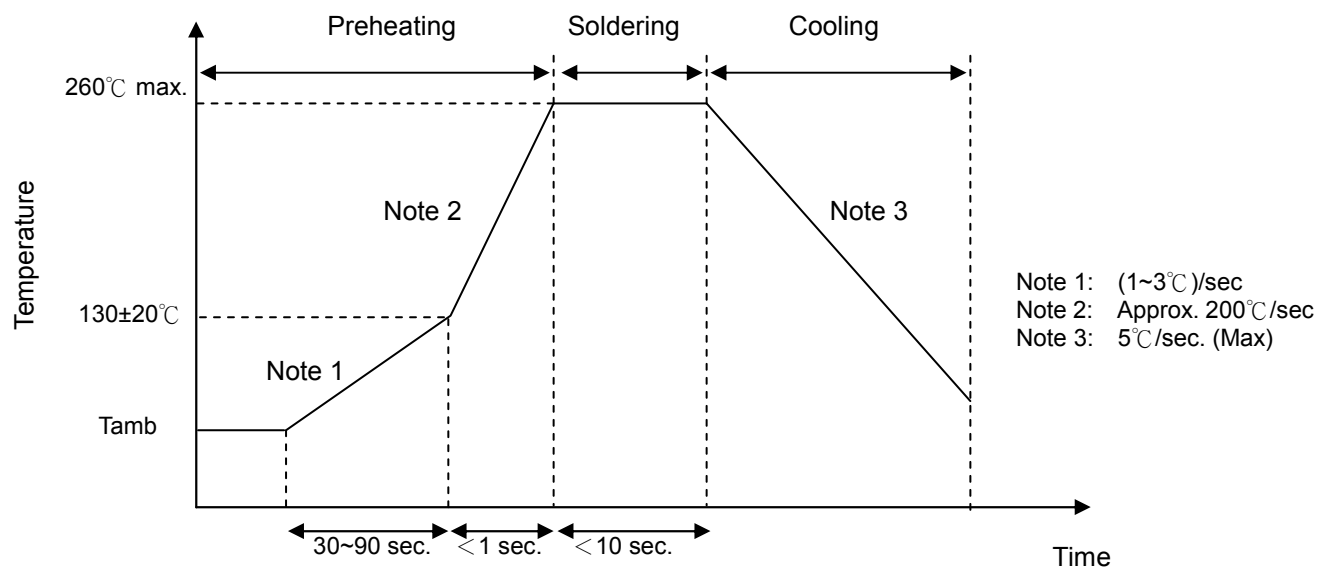

● Recommended Reworking Conditions with Soldering Iron

Item	Conditions
Temperature of Soldering Iron-tip	360°C (max.)
Soldering Time	3 sec (max.)
Distance from Varistor	2 mm (min.)

Metal Oxide Varistor : TVR-M Series

High Temperature Varistor for Surge Protection

■ Reliability

Item	Standard	Test conditions / Methods	Specifications															
Tensile Strength of Terminals	IEC60068-2-21	Gradually apply the specified force and keep the unit fixed for 10±1 sec. Terminal diameter (mm) Force (Kg) 0.5<d≤0.8 1.0 0.8<d≤1.25 2.0	$ \Delta V_{1mA}/V_{1mA} \leq 5\%$ No visible damage															
Bending Strength of Terminals	IEC 60068-2-21	Hold specimen and apply the force specified below to each lead. Bend the specimen to 90°, then return to the original position. Repeat the procedure in the opposite direction. Terminal diameter (mm) Force (Kg) 0.5<d≤0.8 0.5 0.8<d≤1.25 1.0	$ \Delta V_{1mA}/V_{1mA} \leq 5\%$ No visible damage															
Vibration	IEC 61051-1	Frequency range: 10-55 Hz Amplitude: 0.75mm or 98 m/s ² Direction: 3 mutually perpendicular directions, 2 hrs each	$ \Delta V_{1mA}/V_{1mA} \leq 5\%$ No visible damage															
Solderability	IEC 60068-2-20	245±3°C, 3±0.3 sec	At least 95% of terminal electrode is covered by new solder															
Resistance to Soldering Heat	IEC 60068-2-20	260±3°C, 10±1 sec, (5±0.5 sec for TVR05)	$ \Delta V_{1mA}/V_{1mA} \leq 5\%$ No visible damage															
High Temperature Storage	IEC 60068-2-2	150±3°C x 1000± 24 hrs	$ \Delta V_{1mA}/V_{1mA} \leq 5\%$ No visible damage															
Damp Heat, Steady State	IEC60068-2-78	a. 40±2°C, 90 ~ 95 % RH, 1344 hrs b. 40±2°C, 90 ~ 95 % RH, at 10%Vdc, 1344 hrs	$ \Delta V_{1mA}/V_{1mA} \leq 5\%$ No visible damage Insulation Resistance ≥ 100MΩ															
Rapid Change of Temperature	IEC 60068-2-14	The conditions shown below shall be repeated 1,000 cycles <table border="1"> <thead> <tr> <th>Step</th> <th>Temperature (°C)</th> <th>Period (minutes)</th> </tr> </thead> <tbody> <tr> <td>1</td> <td>-40±3</td> <td>30±3</td> </tr> <tr> <td>2</td> <td>Room temperature</td> <td>5±3</td> </tr> <tr> <td>3</td> <td>125±2</td> <td>30±3</td> </tr> <tr> <td>4</td> <td>Room temperature</td> <td>5±3</td> </tr> </tbody> </table>	Step	Temperature (°C)	Period (minutes)	1	-40±3	30±3	2	Room temperature	5±3	3	125±2	30±3	4	Room temperature	5±3	$ \Delta V_{1mA}/V_{1mA} \leq 5\%$ No visible damage
Step	Temperature (°C)	Period (minutes)																
1	-40±3	30±3																
2	Room temperature	5±3																
3	125±2	30±3																
4	Room temperature	5±3																
Endurance at Upper Category Temperature	MIL-STD-202 Method 108	125±2°C, 1000±24 hrs at V _{DC} or V _{rms} (Max. Continuous Voltage)	$ \Delta V_{1mA}/V_{1mA} \leq 10\%$ No visible damage															
8/20μs Surge Life	IEC 61051-1	8/20μs waveform, 10 surge currents, unipolar, interval 30 secs, amplitude corresponding to max. surge current derating curves for 20μs.	$ \Delta V_{1mA}/V_{1mA} \leq 10\%$ No visible damage															
10/1000μs Surge Life	IEC 61051-1	10/1000μs waveform, 10 surge currents, unipolar, interval 2mins, amplitude corresponding to max. surge current derating curves for 1000μs.	$ \Delta V_{1mA}/V_{1mA} \leq 10\%$ No visible damage															
Voltage Proof	IEC 61051-1	Metal balls method, 1000 Vac 1 min	No visible damage															
Varistor Voltage Temp. Coefficient	Specification Standard	$\frac{V_{1mA@125^\circ C} - V_{1mA@25^\circ C}}{V_{1mA@25^\circ C}} \times \frac{1}{100} \times 100\% (\% / ^\circ C)$, $\frac{V_{1mA@-40^\circ C} - V_{1mA@25^\circ C}}{V_{1mA@25^\circ C}} \times \frac{1}{65} \times 100\% (\% / ^\circ C)$	-0.05 ≤ TC ≤ 0.05 (%/°C)															

Metal Oxide Varistor : TVR-M Series

High Temperature Varistor for Surge Protection

■ Packaging

● Taping Specification

L Type (Straight Lead)

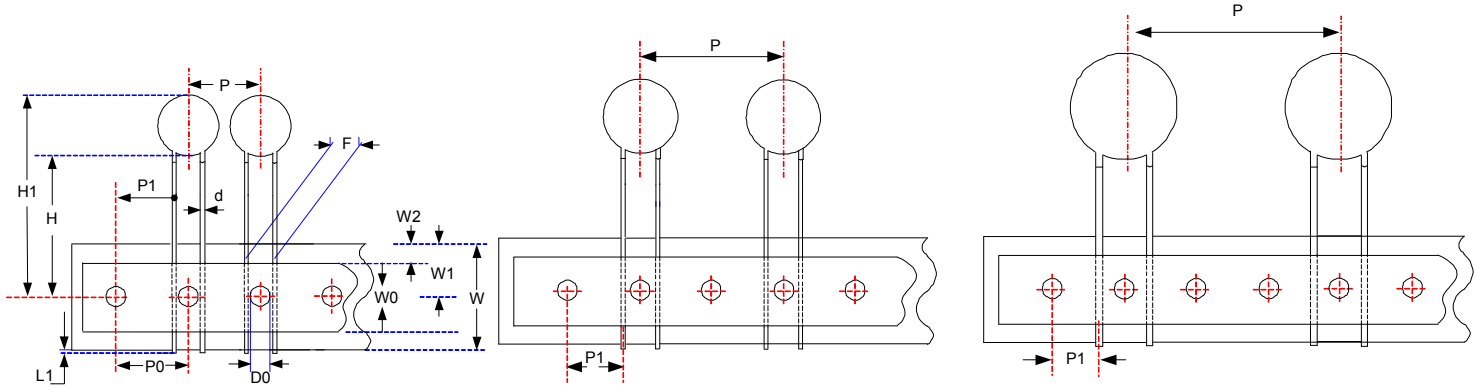

Figure A

Figure B

Figure C

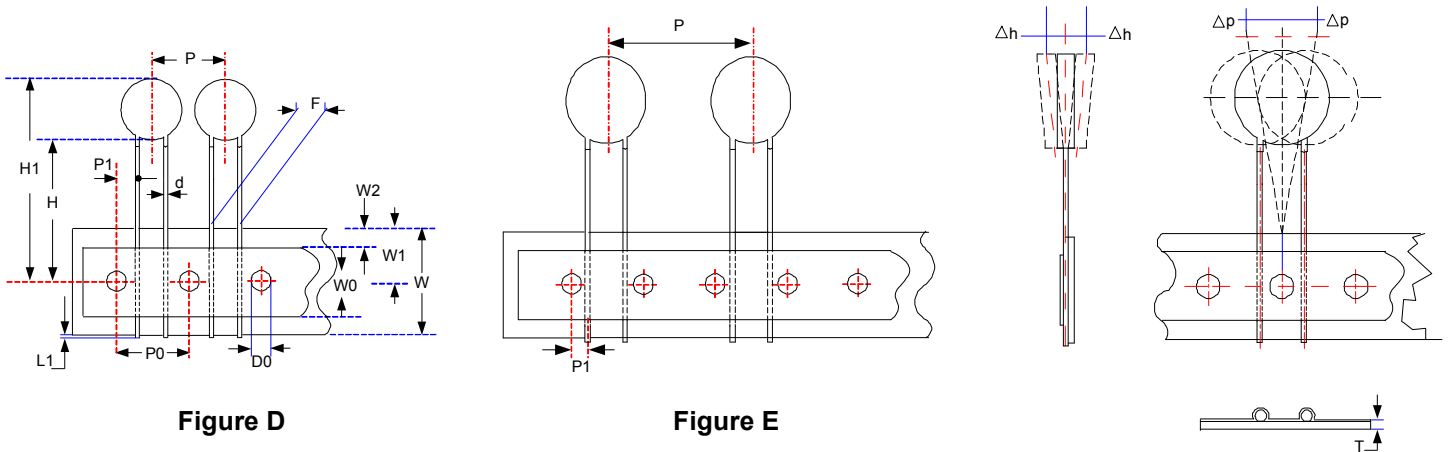

Figure D

Figure E

T

Taping Code	Body Size	P ₀	F	P	P ₁	H	H ₁	d	W ₀	W ₁	W ₂	W	ΔP	Δh	L ₁	D ₀	T	Figure
		±0.3	±1	±1	±0.7	+2/-0	Max.	±0.02	±1	+0.75/-0.5	Max	+1/-0.5	Max.	Max.	Max.	±0.2	±0.2	
A (P ₀ :12.7)	05	12.7	5.0	12.7	3.85	18	28.0	0.6	12	9	3	18	1	2	0.5	4	0.6	D
	07	12.7	5.0	12.7	3.85	18	30.0	0.6	12	9	3	18	1	2	0.5	4	0.6	D
	10	12.7	7.5	12.7	8.95	18	33.5	0.8	12	9	3	18	1	2	0.5	4	0.6	A
	14	12.7	7.5	25.4	8.95	18	38.0	0.8	12	9	3	18	1	2	0.5	4	0.6	B
	20	12.7	7.5	25.4	8.95	18	40.5	0.8	12	9	3	18	1	2	0.5	4	0.6	B
	20	12.7	10	38.1	7.70	18	40.5	1.0	12	9	3	18	1	2	0.5	4	0.6	C
E (P ₀ :15.0)	05	15	5.0	15.0	5.00	18	28.0	0.6	12	9	3	18	1	2	0.5	4	0.6	D
	07	15	5.0	15.0	5.00	18	30.0	0.6	12	9	3	18	1	2	0.5	4	0.6	D
	10	15	7.5	15.0	3.75	18	33.5	0.8	12	9	3	18	1	2	0.5	4	0.6	D
	14	15	7.5	30.0	3.75	18	38.0	0.8	12	9	3	18	1	2	0.5	4	0.6	E
	20	15	7.5	30.0	3.75	18	40.5	0.8	12	9	3	18	1	2	0.5	4	0.6	E

Metal Oxide Varistor : TVR-M Series

High Temperature Varistor for Surge Protection

F Type (Y Kink Lead)

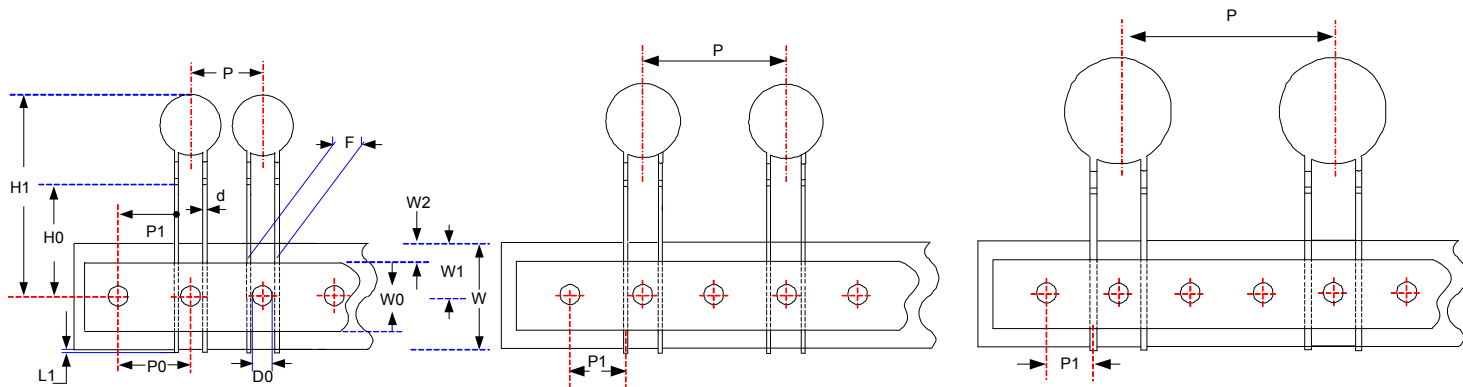

Figure A

Figure B

Figure C

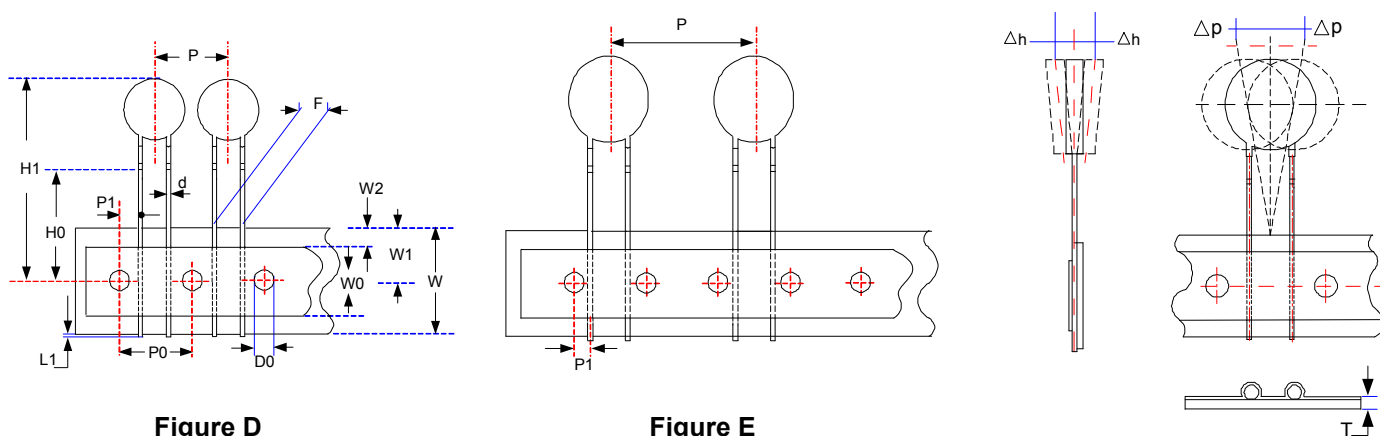

Figure D

Figure E

(Unit: mm)

Taping Code	Body Size	P ₀	F	P	P ₁	H ₀	H ₁	d	W ₀	W ₁	W ₂	W	ΔP	Δh	L ₁	D ₀	T	Figure
		±0.3	±1	±1	±0.7	±0.5	Max.	±0.02	±1	+0.75/ -0.5	Max	+1/ -0.5	Max.	Max.	Max.	±0.2	±0.2	
A (P ₀ :12.7)	05	12.7	5.0	12.7	3.85	16	28.0	0.6	12	9	3	18	1	2	0.5	4	0.6	D
	07	12.7	5.0	12.7	3.85	16	30.0	0.6	12	9	3	18	1	2	0.5	4	0.6	D
	10	12.7	7.5	12.7	8.95	16	33.5	0.8	12	9	3	18	1	2	0.5	4	0.6	A
	14	12.7	7.5	25.4	8.95	16	38.0	0.8	12	9	3	18	1	2	0.5	4	0.6	B
	20	12.7	7.5	25.4	8.95	16	40.5	0.8	12	9	3	18	1	2	0.5	4	0.6	B
	20	12.7	10	38.1	7.70	16	40.5	1.0	12	9	3	18	1	2	0.5	4	0.6	C
E (P ₀ :15.0)	05	15	5.0	15.0	5.00	16	28.0	0.6	12	9	3	18	1	2	0.5	4	0.6	D
	07	15	5.0	15.0	5.00	16	30.0	0.6	12	9	3	18	1	2	0.5	4	0.6	D
	10	15	7.5	15.0	3.75	16	33.5	0.8	12	9	3	18	1	2	0.5	4	0.6	D
	14	15	7.5	30.0	3.75	16	38.0	0.8	12	9	3	18	1	2	0.5	4	0.6	E
	20	15	7.5	30.0	3.75	16	40.5	0.8	12	9	3	18	1	2	0.5	4	0.6	E

(Unit: mm)

Metal Oxide Varistor : TVR-M Series

High Temperature Varistor for Surge Protection

■ Quantity

● Bulk Packing

Series	Straight Lead Type Quantity (pcs/bag)	Cut Lead Type Quantity (pcs/bag)	Kink Type Quantity (pcs/bag)
TVR05-M	250	250	--
TVR07-M	250	250	200
TVR10-M	200	200	200
TVR14-M	100	100	100
TVR20-M	Box Packing: 201~471:400pcs 511 ~621:350pcs 681 ~751:300pcs	50	50

● Reel Packing

Series	A (mm)	Quantity (pcs/reel)
TVR05(201~391)-M	46	1,500
TVR05(431~621)-M		1,000
TVR07(201~391)-M		1,500
TVR07(431~751)-M		1,000
TVR10(201~751)-M		1,000
TVR14(201~391)-M		750
TVR14(431~751)-M		500
TVR20(201~681)-M	55	500
TVR20751-M		250

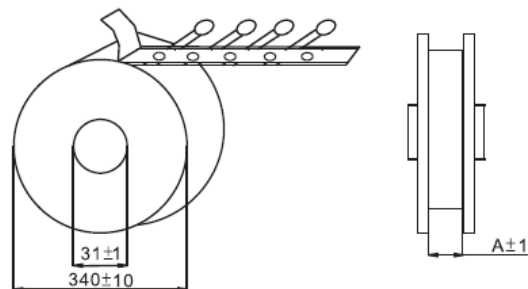

(Unit: mm)

Metal Oxide Varistor : TVR-M Series

High Temperature Varistor for Surge Protection

● Ammo Packing

Series	Quantity (pcs/box)
TVR05(201~391)-M	1,000
TVR05(431~471)-M	1,200
TVR05(511~621)-M	1,000
TVR07(201~751)-M	1,000
TVR10(201~361)-M	750
TVR10(391~621)-M	500
TVR10(681~751)-M	400
TVR14(201~271)-M	500
TVR14(301~751)-M	250
TVR20(201~751)-M	250

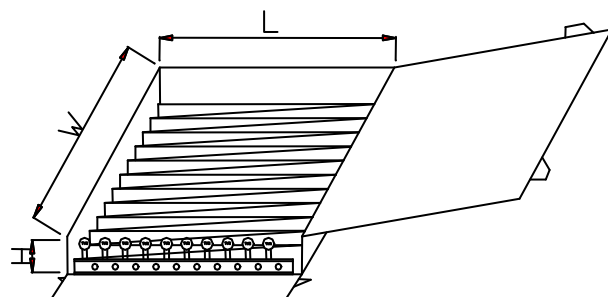

(Unit: mm)

Series	W±5	L±5	H±5
TVR05	348	185	60
~ TVR20-M	348	275	60

■ Warehouse Storage Conditions of Products

● Storage Conditions:

1. Storage Temperature: $-10^{\circ}\text{C} \sim +40^{\circ}\text{C}$
2. Relative Humidity: $\leq 75\% \text{RH}$
3. Keep away from corrosive atmosphere and sunlight.

● Period of Storage: 1 year